



Sunny 512BU
DMX 512 CONTROLLER

User's Manual

Ver 1.06

CODE ELECTRONIC CO., LTD.

Summary

CODE Sunny 512BU scanner console is specially designed to control the various scanners. To adopt double CPU work in coordination, high speed MCU proceed the precise control to achieve 16Bit X/Y movement. Up to 32 scanners may be connected with a maximum of 16 channels each. Multi scenes and multi chase programs can be operated at the same time, and 32 scanners can be selected simultaneously. It is equipped with two groups of DMX 512 signals and is adapted for wide range of power voltage. The edit mode and running mode of the console are convenient and flexible. So it is easy to edit and to handle. Sunny 512BU is the best suit for art show, theater, dancing and acting.

Features

- DMX512/1990 standard, 512 DMX control channels.
- 2 output with optical isolated, withstand 2000Vrms. Independent slot structure, which is easy to change.
- Up to 32 scanners may be connected with a maximum of 16 channels each.
- A large backlight LCD to display operation parameters.
- 16 sliders for channel, 1 slider for speed control.
- 1600 chase steps, 48 chases, up to 100 steps each. Each step contains its speed and cross time, can be set respectively. Trigger mode selectable: Music synchronously and manual speed.
- Cooperating with the chase speed slider, the time of the program step can be changed from 0.03s to 180s.
- 48 scanner scenes can be used directly.
- 8 chases, 48 scenes operated at the same time. At most 32 scanners can be selected simultaneously.
- The X/Y channels of different scanners can be controlled by modulation wheels.
- 16Bit control for absolutely precise movement.
- 15 environment programs to output the combination, which are composed of different scenes, chases and manual output quickly.
- The music trigger source can be selected between audio line input or inside microphone.
- Easy to edit and handle.
- USB Flash Drive enable user to backup the show in a file
- The Data auto-saves.
- High performance switching power supply, with extremely low power harmonious distortion and wide range of voltage, suit for the requirement of different country.

Explanation for Reading

For reading convenience, some signs and usual displays are specially defined as following:

- xxx expresses a key, like HOLD .
- When the parameter is inside [] on display, like [012], the parameter is the current choice.
- Press xx + yy , expresses press xx key first and hold, then press yy key.
- X/Y control is named Pan/Tilt also. In the Manual, it is X/y, the control of X axis/Y axis.
- When the key indicating light is on, it indicates that the key has been pressed, chosen or the function is effective.
- When the indicating light is blink:
 - ◆ BLACKOUT, EDIT function key--emphasizes the function.
 - ◆ Scanner number key-- expresses that the computer is in a hold state.
 - ◆ Scene section key and chase section key - indicate that when multi scenes and multi chases are running, there are scene or chase running on the section.

Cautions

- Danger: there is high voltage inside the equipment, avoid getting an electric shock.
- Caution: please don't open the equipment. There is no part that can be repaired by the user.
- Using the equipment, the power supply must be connected to the earth line to ensure the safety.
- When console and scanner are working, don't plug or pull out DMX512 data cable with the power on. This will destroy the port electric components of the console.
- Don't splash any liquid to the scanner console. This will shatter the inside components of the console and make functions failure.
- Scanner console is precision electric equipment. Please pay attention to moistureproof protection and dustproof protection. And please clean the control panel in schedule with non-chemical cleanser.

Contents

Contents in the package:

- CODE Sunny 512BU scanner console 1
- User's Manual 1
- QC card 1
- Power supply line 1

Connect to scanner

Sunny 512BU console has 2 optical isolated DMX512 signal independent drive device. So there are 2 DMX512 XLR-D3F. The connection of the output socket and the data cable as following:

Foot No.	Data cable
1	Screen net
2	Signal -
3	Signal +

In the end of DMX512 data cable, a 120Ω matching resistor must be connected to the +, - end of the cable to improve the signal transmission quality.

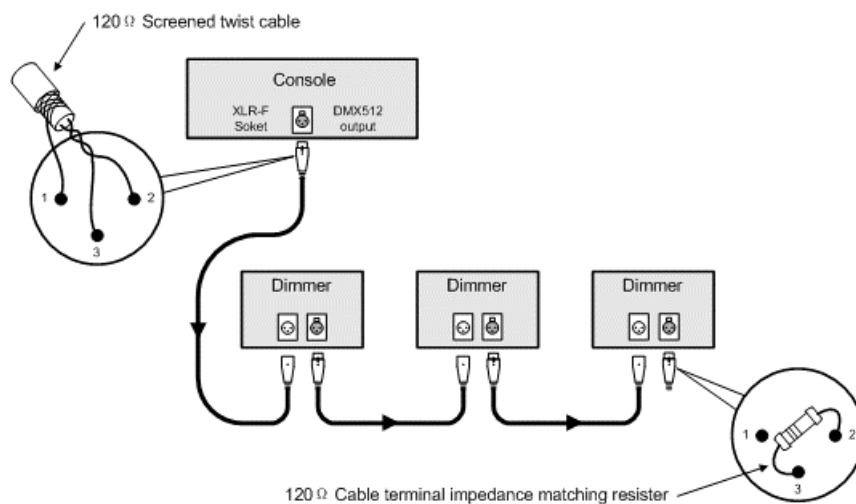

The set of the scanner address

Sunny 512BU console distributes the DMX512 address of various scanners with the fixed space of 16 channels. The reference is as following:

Scanner No	Decimal Code	Binary Code Switch	Scanner No	Decimal Code	Binary Code Switch	Scanner No	Decimal Code	Binary Code Switch
1	001		12	177		23	353	
2	017		13	193		24	369	
3	033		14	209		25	385	
4	049		15	225		26	401	
5	065		16	241		27	417	
6	081		17	257		28	433	
7	097		18	273		29	449	
8	113		19	289		30	465	
9	129		20	305		31	481	
10	145		21	321		32	497	
11	161		22	337				

Since the first address set is different for various scanner manufacturer. There are two ways to express 512 channels: the first is 000~511, the second is 001~512. The above table is suitable for the product of the second way. For the product of the first way, we should subtract one from the above address, and the first bit of the binary code switch should be changed from 1 to 0.

Introduction of the panel

The panel is as following:

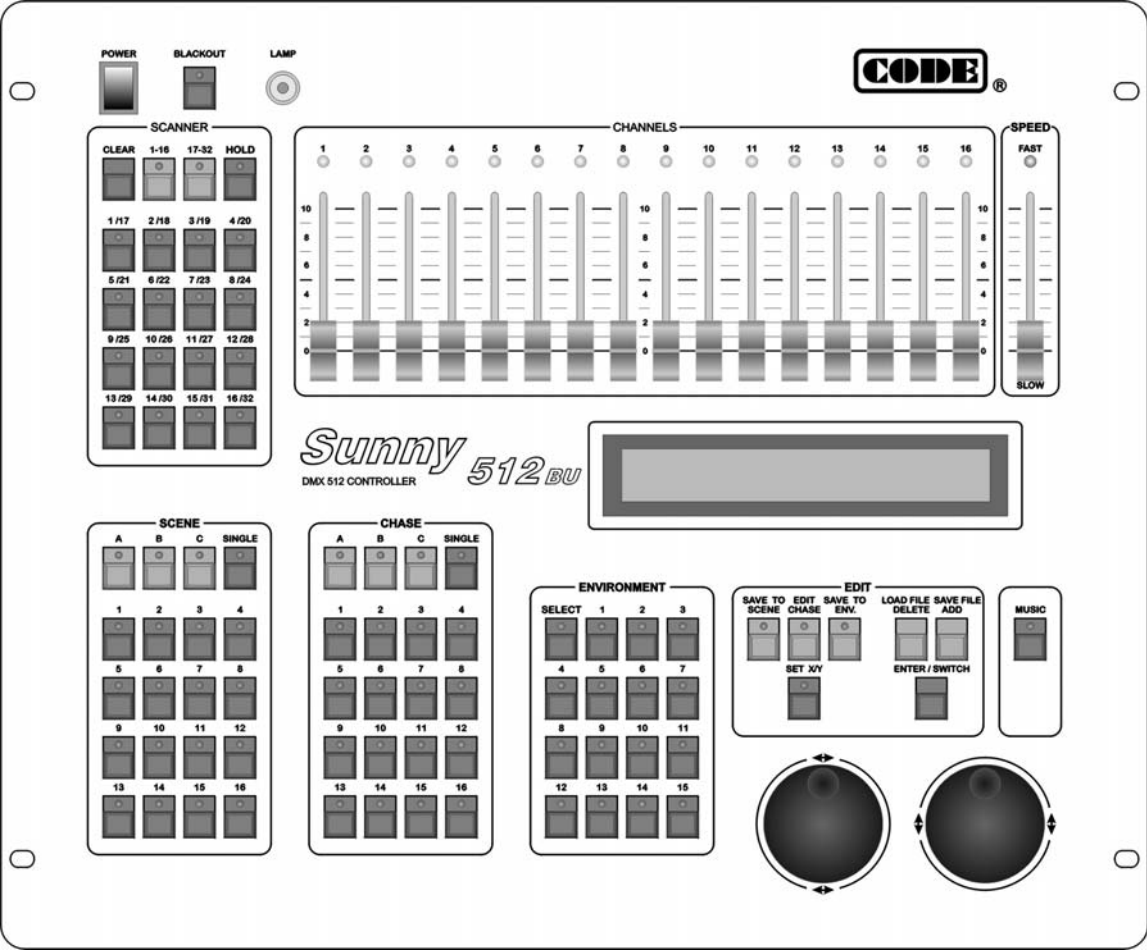

SCANNER

- CLEAR** Clear key
Clear all states chosen by scanner keys and quit manual operation.
- 1-16** Section keys
When the indicating light is on, 1-16 scanner can be chosen from number keyboard.
- 17-32** Section keys
When the indicating light is on, 17-32 scanner can be chosen from number keyboard.
- HOLD** Scanner hold key
When the indicating light is on, it is a scanner hold state. Multi scanner can be manual operated.
- 1** ~ **16** Scanner number keys:
Press these keys, the corresponding indicating lights are on and indicate the scanners are in manual operating states.

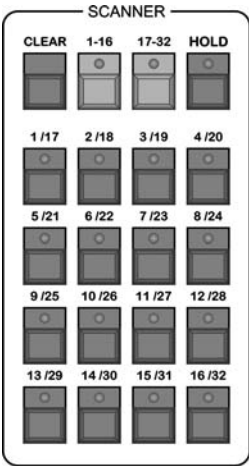

Press again, there are two states:

- **HOLD** light is off: the scanner can't be operated manually.
- **HOLD** light is on: the scanner is in a hold state.

CHANNELS

In manual state, 16 channel slides can set the channel value of the chosen scanner. CHANNELS must cooperate with SCANNER.

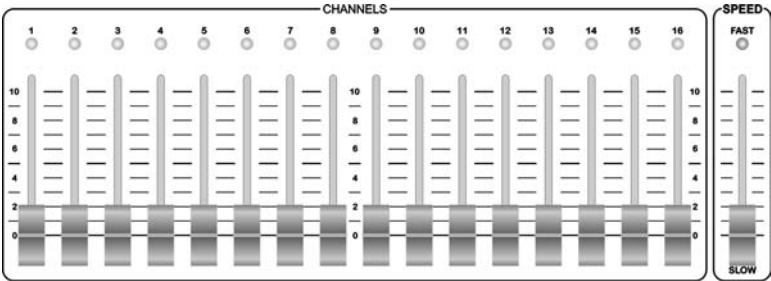

SCENE

Sunny 512BU console can save 48 scenes in 3 saving section with 16 scenes each.

A / **B** / **C** Scene section keys

When the key is pressed, the corresponding indicating light is on and indicates that the section is current section. If current section is A, press scene number key and A01-A16 scene can be operated. If the indicating light of not current section is on, it indicates that there are scenes are running in that section.

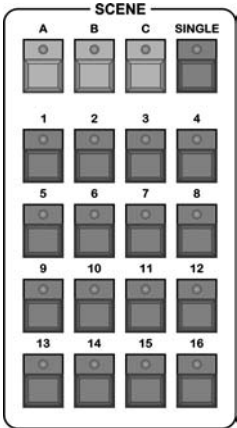

SINGLE Single scene key

Set for each section respectively. The key is used to switch the following states:

- When SINGLE light is on, the current section only can run a scenes.
- When SINGLE light is off, the current section can run multi scenes at the same time.

1 ~ **16** Scene number keys

Cooperating with scene section key, 16 scene keys can operate A01-A16, B01-B16, C01-C16, 48 scenes. Using **SINGLE** key, single scene or multi scenes can be operated.

CHASE

Sunny 512BU console can save 48 chases in 3 saving section with 16 chases each And can run up to the last 8 chases at the same time.

A / **B** / **C** Keys

When the key is pressed, the corresponding indicating light is on and indicates that the section is current section. If current section is A, press scene number key and A01-A16 chase can be operated. If the indicating light of not current section is on, it indicates that there are chases are running in that section.

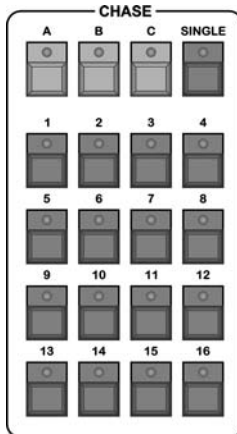

SINGLE Single chase key

The key is used to switch the following states:

- When SINGLE light is on, the current section only can run a chase.
- When SINGLE light is off, the current section can run up to 8 chases at the same time.

The key is effective for 3 chase sections.

1 ~ **16** Chase number keys

Cooperating with chase section key, 16 chase keys can operate A01-A16, B01-B16, C01-C16, 48 chases.

Using **SINGLE** key, single chase or multi chases can be operated.

ENVIRONMENT

SELECT Environment choice key

Press the key first, then press the environment number key, the environment can be run or stopped.

1 ~ **15** Environment number keys

At anytime, only one environment can be chosen.

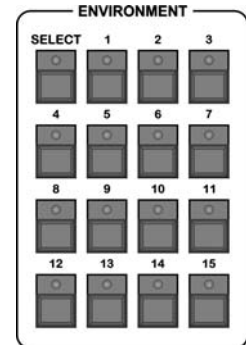

Edit

SAVE TO SCENE Scene save key

Save the current channel values of the scanners to a scene with some number.

Set the channel values of various scanners with manual operation, or add some scenes, then press the key first, and press scene section key and scene number key. The current channel values of the scanners are saved to the number of that section.

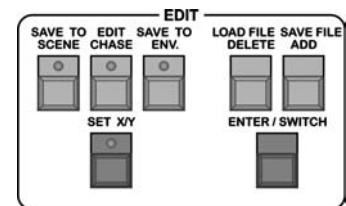

EDIT CHASE Chase edit key

Press the key, the indicating light blink. It is in the chase edit state.

Press the key again, the indicating light is off. The edit result is saved and the edit state is quitted.

SAVE TO ENV. Environment save key

Press the key, then press environment number key, the environment is saved to the number of environment.

SET X/Y X/Y set key

Write the X/Y control channel number of various scanners to the console, then use modulation wheel to control the position of the various scanners.

LOAD FILE / DELETE Import Files / Delete key

Press the key and hold 2 seconds, to import files from USB Drive or when the chase is edited, press the key to delete the current chase step.

SAVE FILE / ADD Backup files / Add key

Press the key and hold 2 seconds, to backup files to USB Drive or when the chase is edited, press the key to add a new chase step after the current one.

If the current chase step is the last one of the chase, the parameters of the current chase step are copied automatically to the new added chase step.

ENTER / SWITCH Enter/Switch key

In scene edit and environment edit, it is ENTER key.
In chase edit, it is SWITCH key.

◀▶, ▲▼ Modulation wheel

In edit chase, **◀▶** is used to change edit item, **▲▼** is used to set the value of the item.
In manual operation mode, **◀▶** is used to set the X position of a scanner, **▲▼** is used to set the Y position.

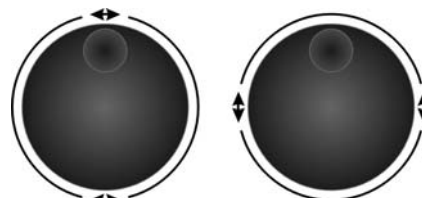

Others

MUSIC Music trigger key

When the indicating light is on, chase follows the music rhythm.
When the indicating light is off, chase follows the set time multiplying the speed percentage set by SPEED slider.

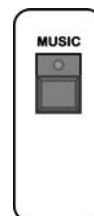

BLACKOUT Blackout key

When the indicating light is blink, console run an inside black scene automatically.
When the indicating light is off, console is in the normal state.

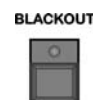

SPEED chase speed slider

Push the slider to FAST, chase runs faster. Push the slider to SLOW, chase runs slower.
chase step Time x SPEED percentage = the actual running time of the current chase step
The changeable range is 300%-30%. When SPEED is 100%, chase step runs on the set time and the set cross time. When the higher speed is needed, SPEED should be adjusted to smaller than 100%. The fast is 1/3 of the standard speed when SPEED is 30%. When the slower speed is needed, SPEED should be adjusted to larger than 100%. The slowest is one third of the standard speed when the SPEED is 300%.



LAMP:

12V work lamp socket. The power of the lamp is smaller than 6W.



POWER: Power switch of the whole equipment.



Introduction to the rear

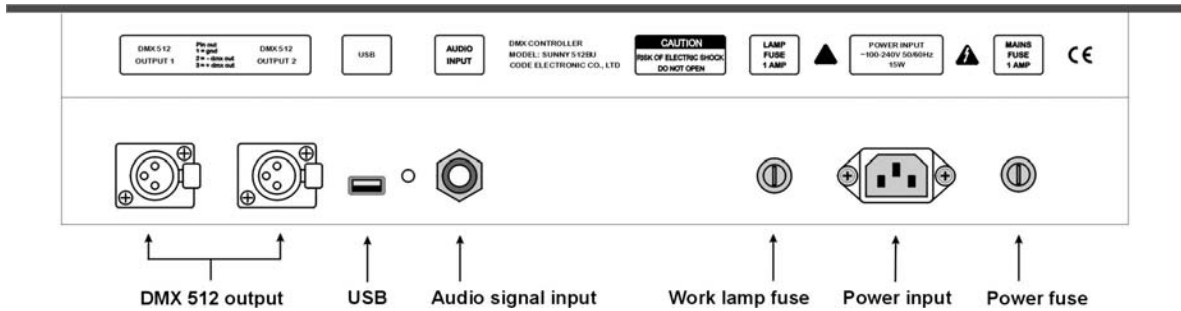

Explanation:

- There are 2 optical isolated DMX512 output sockets, which have the same signals.
- The USB interface is compatible to the USB Drives which meet FAT format, such as USB1.0, USB2.0 and so on.
- Audio signal input socket is a 1/4" mono socket with -10 ~ 0dB input level. When the plug is connected, music trigger signal comes from audio input signal. When the plug is pull out, music trigger signal comes from the environment sound picked by the inside microphone.
- Please use the standard fuse. The standard is printed on the backboard.
- The power supply must be connected to the earth line to ensure the safety.

Set X/Y channels for scanners

Sunny 512BU scanner console can control the scanners with 8Bit or 16Bit X/Y resolution.

Before Sunny 512BU scanner console uses modulation wheels to control the X/Y position of any DMX512 standard scanner, the address of every scanner must be set and the set control channel number of each scanner must be written to the console one by one.

X axis of 16Bit resolution scanner is controlled by two data channels. Y axis is controlled by two data channels, too. So X/Y is controlled by 4 data channels: X axis coarse channel (high 8Bit), X axis fine channel (low 8Bit), y axis coarse channel (high 8Bit), and Y axis fine channel (low 8Bit). For 8Bit resolution scanner, X/Y is controlled by 2 data channels: X axis coarse channel and y axis coarse channel,

The explanations of the display can be seen in append table 1.

Setting operation of X/Y:

From the User's Manual of the scanner, whether the scanner is 8Bit X/Y or 16Bit X/Y and the attribute of the corresponding channel can be known.

1. Press **SET X/Y** key, the indicating light is on. It is in setting scanner's X/Y state.
2. Use scanner keyboard to choose scanner.
3. Use modulation wheel ◀▶ to choose edit item.
4. Use modulation wheel ▲▼ to choose the value of the corresponding channel, range: 1-16, no.
5. Repeat step 2-4 to set X/Y of the other scanners.
6. Press **SET X/Y** key to quit the edit state.

For example:

Some 8Bit scanner
X=5, Y=7.

item	value
X-H	5
X-L	no
Y-H	7
Y-L	no

Some 16Bit scanner
X coarse channel=5,
X fine channel =6,
Y coarse channel=7,
Y fine channel=8.

Item	value
X-H	5
X-L	6
Y-H	7
Y-L	8

The setting of 16Bit scanner:

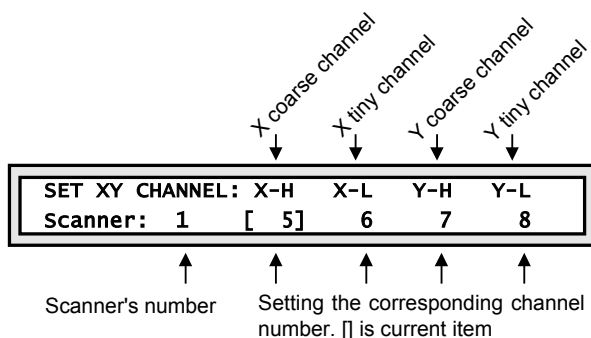

The setting of 8Bit scanner:

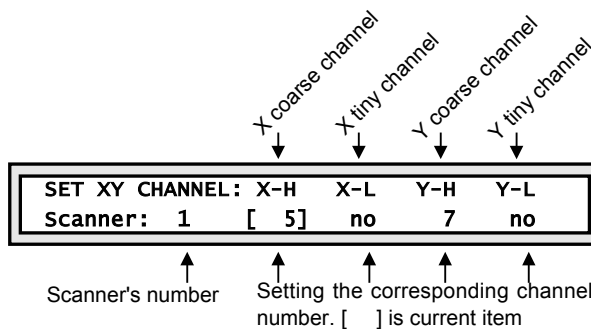

For 16Bit scanner, if the values of X-H,Y-H are set and the values of X-L,Y-L are set to [no], the 16Bit scanner will be running in 8Bit X/Y resolution. This will lost some characteristics of 16Bit scanner, such as high precision of X/Y orientation and the smoothness of the moving trace.

Auto correction to the wrong setting:

X-L=no, Y-L=no must be set at the same time. That just one is 'no' is a mistake. Sunny 512BU checks and corrects X-L, Y-L to be 'no' at the same time automatically.

Check the X/Y setting of the scanners:

Use following ways to check:

1. Press key, the indicating light is on. It is in setting scanner's X/Y state.
2. Use scanner keyboard to choose scanner. Check the X/Y setting.
3. Repeat step 2 to check X/Y setting of all scanners.
4. Press key to quit the edit state.

The manual mode

The scanner's channel values, such as intensity, gobo, X/Y, pattern, and color, can be set manually.

Usually, the control contents of each channel of various scanners are different. With the particular comprehension to the control contents of each channel of various scanners, the scanner connected to the control net can be controlled with facility. The control contents of each channel of ordinary scanners can be seen in the append tables.

In the edit state or running state, it can be operated manually.

Manual operation is the highest priority operation. The chosen scanner will be divorced from the running scene, chase and environment automatically. Manual operation is the basic operation. Manual operation, especially multi scanner manual operation, can be saved as scene, which is the basic operation of edit chase step.

Cooperated with and keys, ~ keys can make choice to 32 scanners.

When the number indicating light is on, that scanner is in the chosen state. It can be set by CHANNELS sliders and modulation wheels.

CHANNELS 1-16 channel sliders and modulation wheels

The values of each channel of scanners can be set by 1-16 channel sliders. X channel of a scanner is set by modulation wheel ◀▶. Y channel is set by modulation wheel ▲▼. The set range of a slider is 0-255. Whether 8bit or 16Bit X/Y scanner, the set range of a modulation wheel is 0-999. It represents the moving range of X axis or Y axis. For 16Bit scanner, modulation wheel ◀▶ controls X-H and X-L at the same time. Modulation wheel ▲▼ controls Y-H and Y-L at the same time. For 8Bit scanner, modulation wheel ◀▶ controls X-H only. Modulation wheel ▲▼ controls Y-H only.

When the X/Y channel is controlled by modulation wheels, the corresponding X/Y slider is locked. The X/Y position of a scanner must be set by modulation wheels.

In the manual mode of a scanner, slider and modulation wheels can change the value of the corresponding channel. The screen displays the value of these channels.

When the scanner key is pressed, the X/Y current appears at the right part of the screen. Turn the modulation wheels, the values of X/Y can be changed.

Move 1-8 channel slider, the screen displays:

CH	1	2	3	4	5	6	7	8		X:120
	123	58	204	32	12	0	0	0		Y:891

Move 9-16 channel slider, the screen displays:

CH	9	10	11	12	13	14	15	16		X:120
	0	0	14	128	0	0	0	0		Y:891

Note: the values of channel and X/Y depend on the slider position and the X/Y modulation wheel value. In a moment of slider moving, the value display will disappear until the next moving.

Manual operation of single scanner

1. Press **HOLD** key to make the indicating light off.
2. Choose scanner: press scanner number key (cooperate with **1-16** and **17-32** keys), the indicating light is on.
3. Use CHANNELS sliders to set the channel values, use modulation wheel **◀▶** and **▲▼** to adjust X/Y position.

Manual operation of the same kind multi scanners

1. Press **HOLD** key to make the indicating light off.
2. Choose scanner: according to the 2 step of Manual operation of single scanner, multi scanners can be chosen. (Note: only the scanners with the same X/Y channel can be chosen at the same time.)
3. Use CHANNELS sliders to set the channel values. Use modulation wheel **◀▶** to adjust X position. Use modulation wheel **▲▼** to adjust Y position. And the adjusted channel values are set to all chosen scanners at the same time.

Manual operation of the different kind of multi scanners

For the manual operation of the different kind of scanners, set one kind of the scanners and make these scanners in the hold state first. Then choose another kind of the scanners to set. This is also the usual operation method to set 1 scene. The hold state of the scanner can be change to the choosing state by pressing its key to make the indicating light on.

1. Press **HOLD** key to make the indicating light on.
2. Choose scanner: use the way of choosing single scanner or multi scanners to choose scanners. (Note: only the scanners with the same X/Y channel can be chosen at the same time.)
3. Use CHANNELS sliders to set the channel values. Use modulation wheel **◀▶** and **▲▼** to adjust X/Y position.
4. Press the corresponding number key of the chosen scanner to make the indicating light blink. The set values of these scanners are in the hold state. And the adjusted channel values are set to all chosen scanners at the same time.
5. Repeat 2-4 steps to set other scanners manually.

Cancel the manual operation of scanner

Press **CLEAR** key, the manual operation is canceled and the set values of the scanners can not be saved.

Scene Edit

The appropriate values of channels (such as color, intensity, pattern, X/Y, and so on) of various scanners can make a needed light art pattern in the space-scene. Each scene is an aggregate of the set channels of the various scanners. Sunny 512BU console can save 48 scanner scenes. The saved scenes can be run at any moment.

Important tips

For the simultaneous running of the multi scenes and multi chases, the different values of the same channel which are produced at the same time are treated by HTP Technique. So following setting is proposed:

1. For all scenes which just include pattern effect controls, such as color, pattern, and so on, the values of X/Y, intensity, and so on are set to 0.
2. If chase just include the controls like X/Y, intensity, and so on, the values of the other channels are set to 0.

Process of scene edit:

1. According to the ways of manual operation, choose scanner and set the various channel values and X/Y position.
2. Press **SAVE TO SCENE** key, then press scene district key and scene number key. In the end, press **ENTER / SWITCH** key to confirm the save.

Example:

If you want to save the current scanner running states to A13 scene, press **SAVE TO SCENE** key, then press **A** key in SCENE, and press **13** key, in the end, press **ENTER / SWITCH** key.

Tips:

Scene edit can be done at any time. After the various setting to multi scanners, if the art pattern is what you want, just perform the above step 2. The running states of all scanners can be saved to a scene number. For instance, using simultaneously running scene B02 and C07 as basic, choose 3 scanners manually and set the light beam to some position, then save the combination to scene C01. So, run C01 can recur this light art pattern combination.

Copy of Scene

Example: Copy scene A01 to scene C10.

1. Press **A** key in SCENE, then press **1** key. Then the console run A01 scene.
2. Press **SAVE TO SCENE** key, press **C** key in SCENE, then press **10** key and **ENTER / SWITCH** key.

Chase Edit

Sunny 512BU console can save 48 chases.

A chase is a buildup of some chase steps. The concept of chase step is very similar to the scene.

A chase step is made up of the aggregation of each channel value of various scanners, the step time and the graduate change parameter Cross.

The total capability of the chase step is 1600. Each chase can have up to 100 step. In each step of a chase, the step time and the gradual change parameter Cross can be set independently. The standard operating speed of a chase is decided by the step time and the gradual change parameter Cross of a step. The speed can be adjusted from 1/3 to 3 times as the standard speed by SPEED slider.

Step time value

The value defines the interval time between the current to the next step. The unit is 0.1s. The changeable range of Time is 1-600. It means that the minimum time of a step is 0.1s and the maximum is 60s.

Cross value

The value defines the time ratio of the gradual change treatment between two chase steps. The range of the value is 0-100%. For instance, in the current step, Time=10, Cross=60% express that the current step will use 1 second and use 40% of this 1 second as stay time, 60% as gradual change treatment time for moving to the next step.

Process of chase edit

1. Press **EDIT CHASE** key.

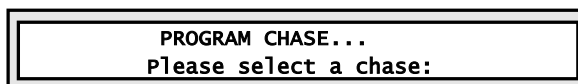

2. Choose the chase number which will be edited. For instance, if want to edit chase C15, press **C** key in CHASE, then press **15** key. if the chase is empty, the screen will display:



3. Press **ADD** key to add a step.

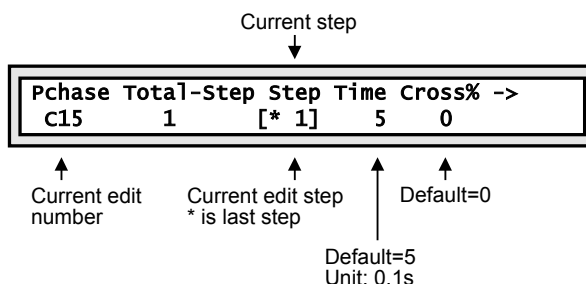

4. Use modulation wheel ◀▶ to change the items, such as STEP, TIME and CROSS. Use modulation wheel ▲▼ to set the value of the current item.
 - If current STEP xx is the last one of CHASE, the relevant character will be display as *xx. For example: The last step of current chase is 20, the relevant character be displayed as *20.
 - The scale of TIME: 1 - 600, unit is 0.1 second. The value of TIME defines the interval between current step and next step.
 - The scale of CROSS: 0 – 100%. The value of CROSS defines the proportion of TIME for fulfilling Cross process.

For example: TIME=100, CROSS=70%, the hold time at last step=10s × (1-70%)=3s;

Residual time for transferring from last step to next step.

Total time for processing is 10s × 70%=7s.

5. Set the channel values of various scanners in the current step manually. Use **ENTER / SWITCH** key to change the setting state of chase step, the various channel values of manual operating scanners, and the setting state of X/Y.
6. Repeat step 3-5 to edit next chase step.
7. Press **EDIT CHASE** key to end edit.

Tips:

- When **ADD** key is pressed to add a chase step, the values, such as the channel values of all scanners, the values of TIME and CROSS are copied to the new added chase step automatically. So just change some items to make a new chase step.
If the current chase is empty, all channel values are set to 0.
- In the edit state, use **ENTER / SWITCH** key to switch between the chase setting state and manual setting state, which set the various channel values and X/Y values of scanner. In different state, the control object of the modulation wheel is different. In chase setting state, use modulation wheel ▲▼ to change the current step. This can check the space pattern effect of every chase step and can change the channel values of some scanners in the current chase step immediately.
- Press **DELETE** key to cancel the current chase step.

Environment Edit

The current manual operating state, scene operating state and chase operating state are the operating environment. If the current environment is saved, it is very convenient to reuse this environment.

A complex environment, like an environment + some chases + some scenes + some manual operation, can be saved as an environment. It can be saved to cover the original environment number or saved as another environment number.

Sunny 512BU console can save 15 environment. The environment can be chosen by keyboard directly. To avoid mistake made by touching keyboard by accident, it is needed to press **SELECT** key first and then press the environment number key to choose the environment.

Edit process:

1. Base on the need to choose the following operating mode:
 - a) Scanner manual operation.
 - b) Scene operation (multi scenes running simultaneously)
 - c) Chase operation (up to 8 chase running simultaneously)
2. After pressing **SAVE TO ENV.** key:
 - a) If no environment program in current environment, the screen displays as left figure.

Save the Current Environment to: ok->
 - b) If the current includes the environment program, the number of the environment is displayed.
If **ENTER / SWITCH** key is pressed, the current environment will cover the contents of the original environment. If it is needed to save to another number, then...
3. Press **SELECT** key.
4. Press **1** ~ **15** key.
5. Press **ENTER / SWITCH** key to conform.

Tips:

To save the environment, it is not needed to press **SELECT** key first.

To run environment, it is needed to press **SELECT** key first and then press number key.

Data Backup & Restore With USB Flash Drive

Sunny 512BU can backup 48 files into a USB Flash Drive, and can upload one of the files from USB Flash Drive.

Process:

1. Backup the files with USB:
 - a) Insert the USB Flash Drive into the USB jack at the back of the console;
 - b) Press **SAVE FILE** key;
 - c) Select **1** ~ **16** key(s) of **SCNNER**, **SCENE** and **CHASE** to export the data to USB;
 - d) Press **ENTER / SWICTH** key to validate.
2. Upload one file with USB:
 - a) Insert the USB Flash Drive into the USB jack at the back of the console;
 - b) Press **LOAD FILE** key;
 - c) Select **1** ~ **16** key(s) of **SCNNER**, **SCENE** and **CHASE** to import the data from USB;
 - d) Press **ENTER / SWICTH** key to validate.

Running

Running scene

Example 1:

Single running scene A01.

1. Close running scene B and C one by one.
2. Press **A** key to choose A as the current district.
3. Press **SINGLE** key to make SINGLE indicating light on. A district is in the single scene running mode.
4. Press **1** key to run scene A01.

Example 2:

Run A02, A10, B15, C07 scenes at the same time.

1. Press **A** key to choose A as the current district.
2. Press **SINGLE** key to make SINGLE indicating light off. It is in the multi scene running mode.
3. Press **2** key to run scene A02.
4. Press **10** key to run scene A10.
5. Press **B** key, **15** key to run scene B15.
6. Press **C** key, **7** key to run scene C07.

Now, the above scenes are running simultaneously.

Tips

In the step 3 of example 2, if press **SINGLE** key to make SINGLE indicating light on, perform step 4 to run scene A10 and scene A02 will close automatically.

Running chase

Running chase, the screen will display:

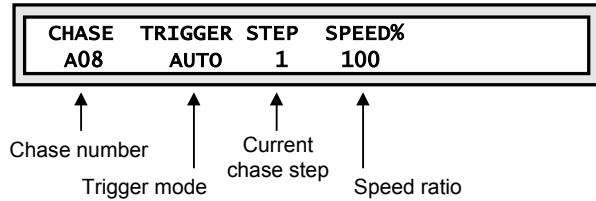

Example 3:

Running chase A08.

1. Press SINGLE key of CHASE to make SINGLE indicating light on. It is in the single chase running mode.
2. Press A key to choose A as the current district.
3. Press 8 key to run chase A08.

Example 4:

Run A04, A13, B07, C10 chases at the same time.

1. Press SINGLE key of CHASE to make SINGLE indicating light off. It is in the multi chase running mode.
2. Press A key to choose A as the current district.
3. Press 4 key to run chase A04.
4. Press 13 key to run chase A13.
5. Press B key to choose B as the current district.
6. Press 7 key to run chase B07.
7. Press C key to choose C as the current district.
8. Press 10 key to run chase C10.

Now, the above 4 chases are running simultaneously.

Tips

If the chosen chase is empty (without chase step), the screen will display:



● **Check the various operating parameters of multi chases running simultaneously**

When multi chases are running, the last parameters are displayed in the screen. In example 4, the parameters of last chase C10 are displayed in the screen.

If the parameters of some chases are want to be change, the chase must be set as current chase and the chase is display in the screen. For instance, in example 4, here the parameters of last chase c10 are displayed in the screen. If the parameters of B07 are wanted to be seen, just press B + 7 . (press B key and hold, then press 7 key)

This method does not affect the current chase running.

● **Adjust chase speed**

The operating speed of the current chase can be change by moving SPEED slider.

~~chase step time value x speed ratio = real running time of the current chase step~~

Using the method of checking operating parameters of multi chases running simultaneously, make a chase to be current chase one by one. Then set its chase speed.

● **The music trigger of a chase**

Press MUSIC key to make MUSIC indicating light on. It indicates that the current chase is in the music in-phase trigger state. In this state, the chase step time and the gradual change ratio Cross don't work.

Run Environment

Press **SELECT** key, then press **1** - **15** number key to make the corresponding indicating light on. The chase, scene, and manual operating included in this environment will reappear. Every corresponding indicating lights are on.

Example 5:

Run Environment 1.

1. Press **SELECT** key.
2. Press **1** number key.

Press **SELECT** key again, and press the number key which light is on. The corresponding environment is closed. Then the original state will run continually.

Addenda

Table 1:
Explanations to display contents

Display contents	Explanations
X-H	X axis coarse channel (high 8Bit channel)
X-L	X axis fine channel (low 8Bit channel)
Y-H	Y axis coarse channel (high 8Bit channel)
Y-L	Y axis fine channel (low 8Bit channel)
No	For 8Bit scanner, only X/Y coarse channel can be used. So the X/Y fine channel must be set to [no].
CH	Abbreviation of CHANNEL
*	The chase step with * is the last step of the current chase.
->	Use ENTER / SWITCH key can switch the display contents.
[]	The parameter in the [] is the current adjustable item. Its value can be change by modulation wheel.
PROGRAM CHASE...	Chase edit state
CHASE: xxx Step is empty!	The chase with this number is empty! (the chase number is replaced by xxx)
MEMORY IS OVERFLOW!!	There is no space in memory.

Table 2:
Control channel data of the ordinary scanner

Scanner model	Channel	Control type
CLAY PAKY GOLDEN SCAN HPE (Golden scanner)	1	IRIS
	2	Color Disc1
	3	Color Disc2
	4	Dimmer / Strobe
	5	PAN
	6	TILT
	7	Frost and Effect
	8	Prism Rotation
	9	FOCUS
	10	Fixed Gobo Select
	11	Rotation Gobo Select
	12	Gobo Rotation
SGM GALILEO II	1	IRIS
	2	Color Select
	3	Gobo Select disk1 / disk2
	4	Shutter Strobe
	5	PAN
	6	TILT
	7	Gobo Rotation
	8	DIMMER
SGM GALILEO	1	IRIS
	2	Color Select
	3	Gobo Select disk1 / disk2
	4	Shutter Strobe
	5	PAN
	6	TILT
Trackspot (Bond scanner)	1	PAN
	2	TILT
	3	Color
	4	Gobo
	5	Shutter
	6	Dimmer
	7	Motor Speed
Martin Roboscan Pro 1200 XR (Protocol 1) (Martin scanner 1200XR)	1	Strobe, Fan Speed, Lamp on / off, Reset Fixture
	2	Intensity
	3	Color
	4	Gobo 1 / Fixed Gobos
	5	Rotating Gobo selection
	6	Rotating Gobo Index/Continuous Rotation
	7	Focus
	8	Iris
	9	Prism
	10	Pan
	11	Tilt
Martin Roboscan Pro 518 (Mode 3) (Martin Scanner 518)	1	Strobe, Fan Speed, Lamp on/off, Reset fixture
	2	Dimmer
	3	Color
	4	Rotating Gobo
	5	Effect Wheel
	6	Pan
	8	Tilt
Martin Roboscan Pro 218 (Mode 3) (Martin scanner 218)	1	Shutter / Strobe / SA /Reset fixture
	2	Dimmer
	3	Color
	4	Gobo
	5	Pan
	7	Tilt
FAL ITALSCAN HMI 1200 (Fly eagle scanner)	1	-
	2	Color
	3	Gobo
	4	Strobe
	5	Pan
	6	Tilt

Technical specification

Digital control mode	DMX512/1990
DMX control channel amount	512
Control scanner amount	32
Control channel distribution of a scanner	16
control resolution of a scanner	16bit
optical isolated independent digital output drive module	2
Electrical isolation of optical isolated independent digital output drive module	2000VDC
LCD backlight screen	40 character x 2 row
BLACKOUT function	✓
Manual operation function	✓
Simultaneous manual operation ability	32
Scanner scene	48
Scene amount of simultaneous running scanners	48
Scanner chase	48
Maximum chase steps in a chase	100
Chase step time	0.1s – 60s
Chase gradual change ratio Cross	0-100%
Total capability of chase steps	1600
Chase amount of simultaneous running scanners	8
Music in-phase chase	-10 ~ 0dB audio line input/inbuilt microphone
Channel sliders	16
Speed slider	1
The ratio range of chase speed	30%-300%
MODULATION WHEEL	2
Environment	15
Copy of scanner scene	✓
All scanner X/Y channels can be controlled by modulation wheel	✓
Data auto save	✓
Backup or restore with USB Flash drive	The USB interface is compatible to the USB Drives which meet FAT format, such as USB1.0, USB2.0 and so on
DMX signal output connector	XLR-D3F x 2
Audio signal input connector	1/4" mono socket
Power supply range	AC 100V-240V, 50-60Hz
Consume power	18VA max.
Work temperature range	0-40 C°
Work environment	Waterproof, dustproof
Size	483mm x 400mm x 105mm
Weight	8kg

MEMO